

U-Sten set fra siden

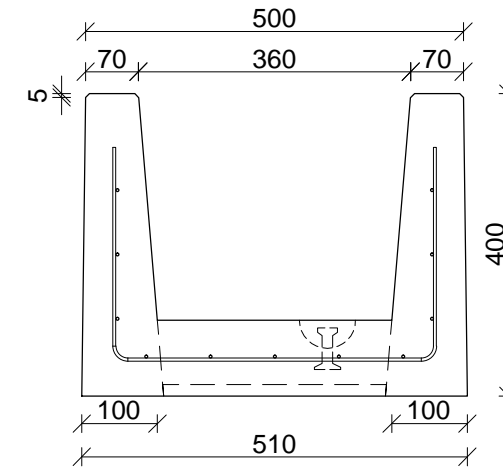

Snit A-A

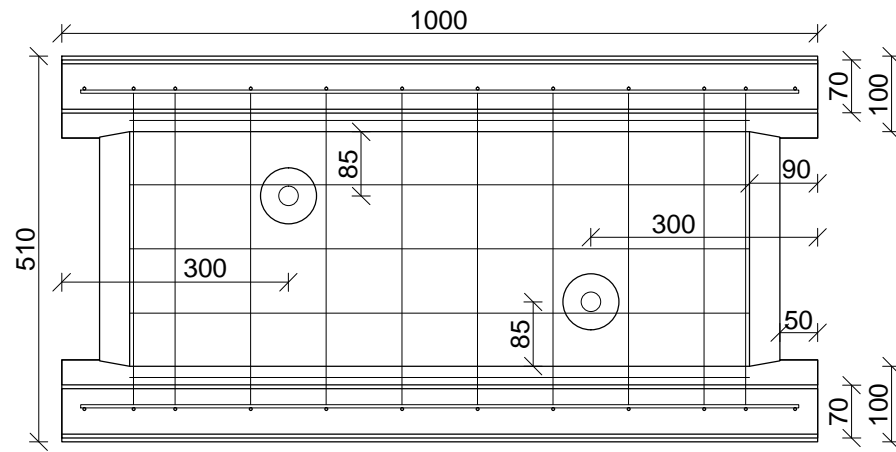

U-Sten set fra oven

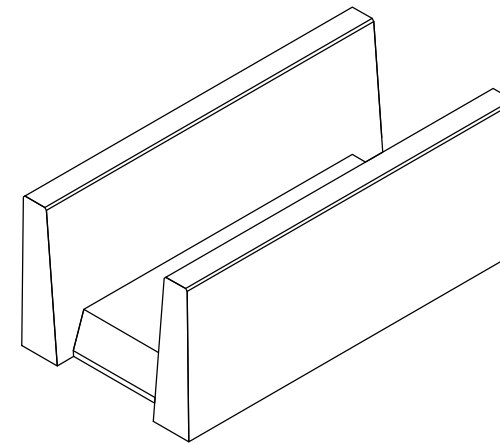

Data		
Bredde (Modul-/basismål)	Bund: 510 mm / 507 mm +/- 5 mm - Top: 500 mm	
Højde	400 +/- 5 mm	
Længde (Modul-/basismål)	1000 mm / 997 +/- 5 mm	
Beton	Beton 35 grå/ overflade glat	
Armering	Ø4 mm armeringsnet (se tegn P-U-L100-3)	
Løfteankre	2 stk Starcon 2,5 T/55 mm	
Vægt/stk	230 kg/stk	
Emne: U-Sten 50x40x100 Plan, snit og opstalt	Tegn nr.	P-U-L100-1
	Mål:	1:10
Sag: Standard U-Sten 50x40x100 med udsparring	REV:	
	Ordre nr. :	Standard
	Dato:	08/02-2017
	Tegn. af:	SSM
Oranje Beton A/S - Frøjkvej 27 - 7500 Holstebro Telefon 97 42 31 33 - Fax 97 42 30 22 Mail mail@oranje.dk - WEB www.oranje.dk		