

OVERSIGT KABELRENDER

Kabelrender Type 1

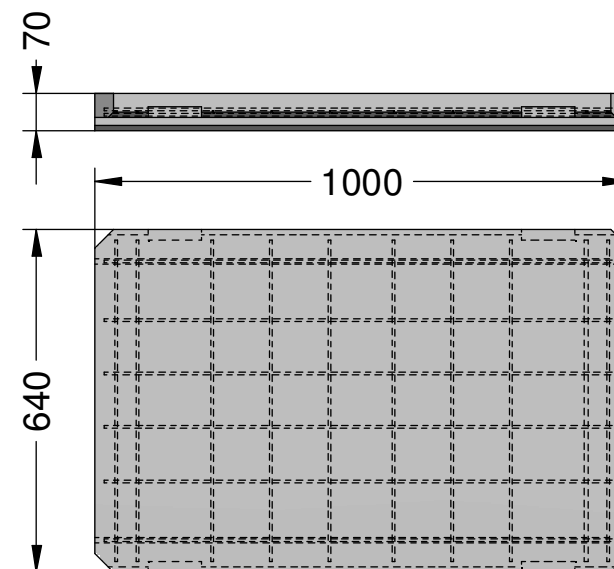
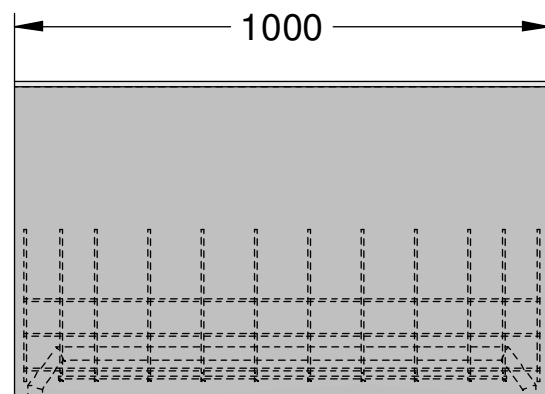
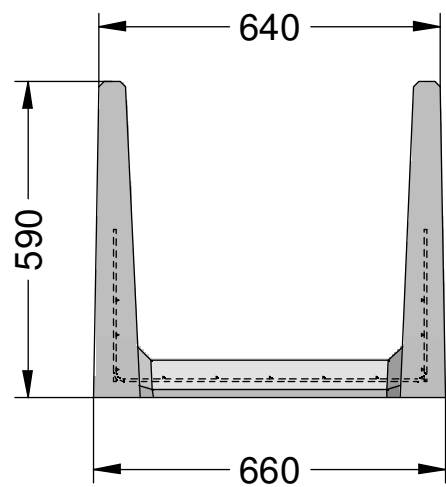

Låg Type 1

Kabelrender Type 2

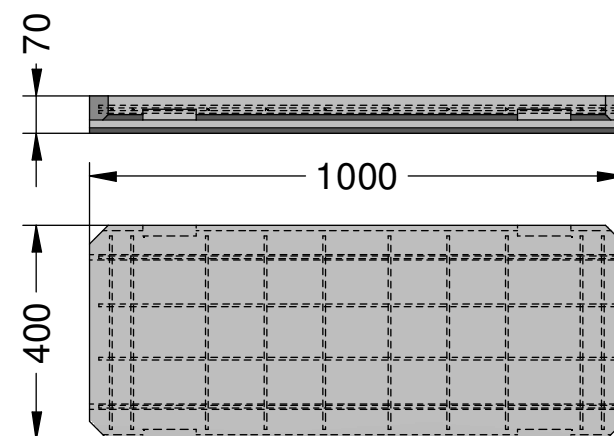
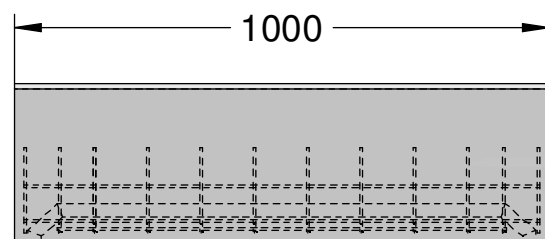
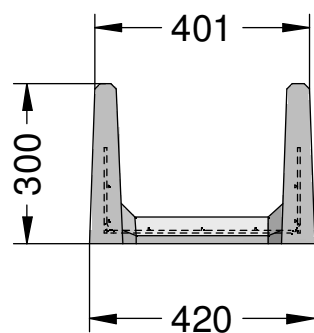

Låg Type 2

Kabelrender Type 3

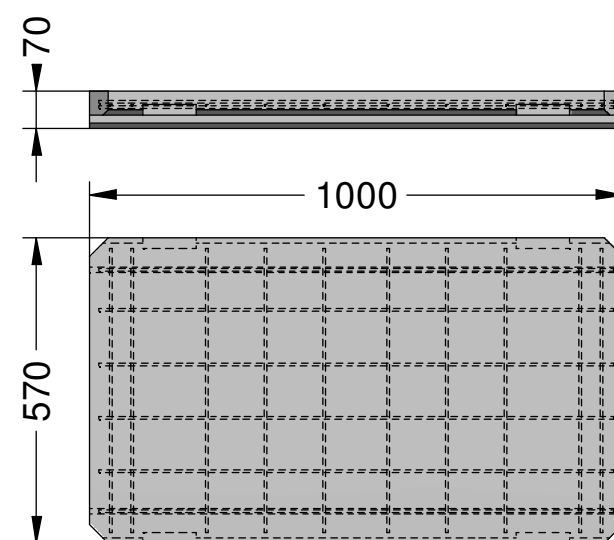
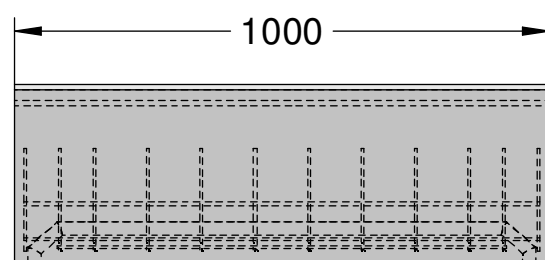
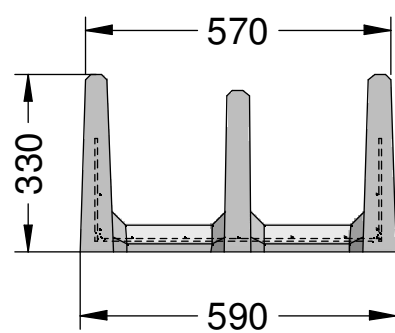

Låg Type 3

 Oranje Beton A/S - Frøjkvej 27 - 7500 Hølstebro Telefon 97 42 31 33 - Fax 97 42 30 22 www.oranje.dk	Tegn.	Kontrol	Dato
	SimasR	JørgenDau	2015-04-09
Side 1 af 3	Sagsnr.	Tegningsnr.	
	NV3737	00091305-01	
	Element nr.	Montage nr.	
Kabelrender Type 1			

OVERSIGT KABELRENDER

Kabelrender Type 4

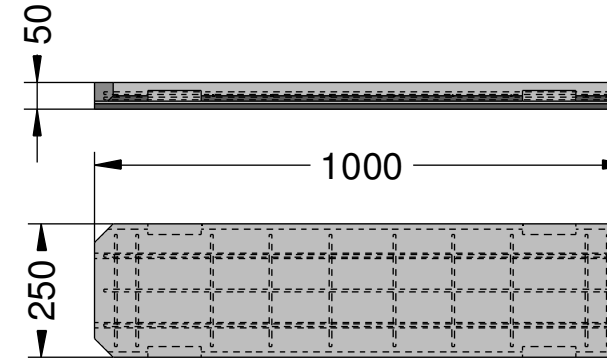
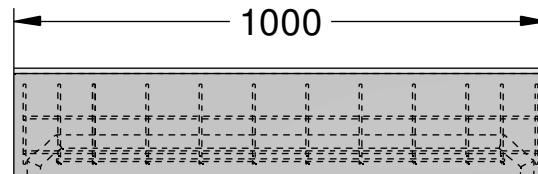
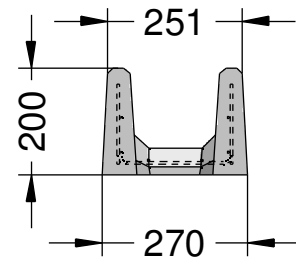

Låg Type 4

Kabelrender Type 5

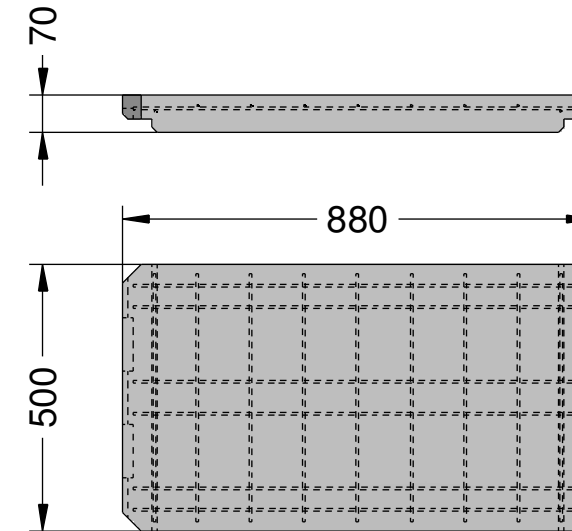
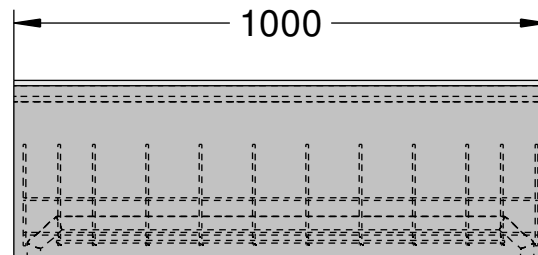
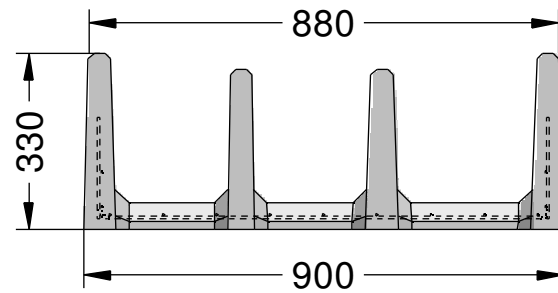

Låg Type 5

 Oranje Beton A/S - Frøjkvej 27 - 7500 Hølstebro Telefon 97 42 31 33 - Fax 97 42 30 22 www.oranje.dk	Tegn. SimasR	Kontrol JørgenDau	Dato 2015-04-09
	Side 2 af 3	Sagsnr. NV3737	Tegningsnr. 00091305-01
Kabelrender Type 1		Element nr.	Montage nr.

OVERSIGT KABELRENDER

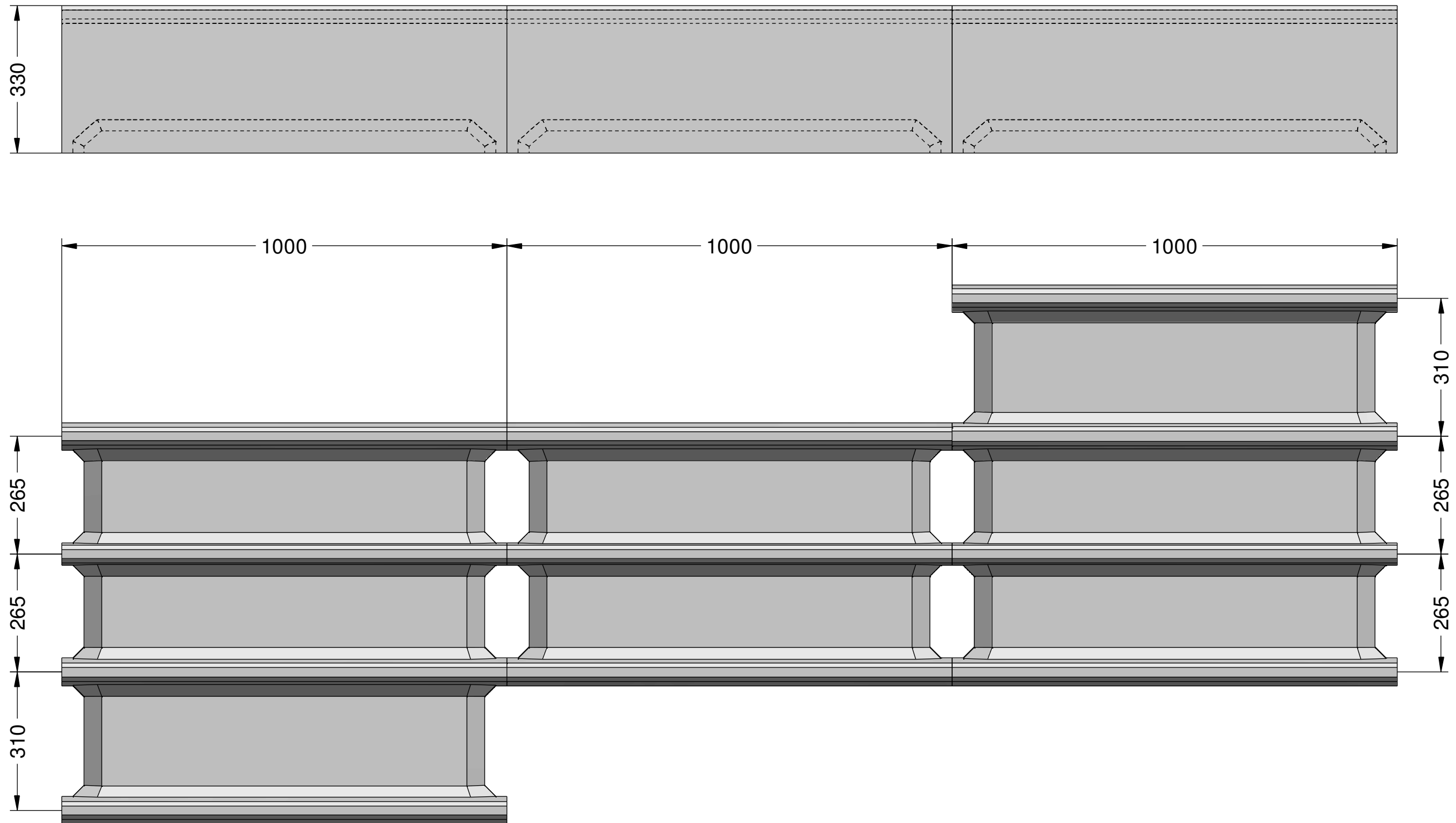

Kabelrender Type 5

Kabelrender Type 3

Kabelrender Type 5

 Oranje Beton A/S - Frøjkvej 27 - 7500 Hølstebro Telefon 97 42 31 33 - Fax 97 42 30 22 www.oranje.dk	Tegn. SimasR	Kontrol JørgenDau	Dato 2015-04-09
	Side 3 af 3	Sagsnr. NV3737	Tegningsnr. 00091305-01
Kabelrender Type 1		Element nr.	Montage nr.